

# NF12-100

12V100Ah / 10hr rate



### Introduction

**Genergy NF (Front Terminal) series** is designed for telecommunication UPS/EPS system with 12-year design life in float service. The battery is featured of high consistency, excellent performance and reliable standby service life.

### Battery Features

- Compactness
- ETSI 19 inch / 23 inch integration
- Rackable standard component
- High power to volume ratio
- Modularity
- Long life
- Front connection and terminal access
- Central gassing system and hinged front covers on all models
- Fully tank formed plates
- Low impurity electrolyte
- Multi-position usage
- Spill proof / leak proof
- ABS case and cover VO upon request
- Very high purity lead

### Electrical Specification

Design floating Life @ 25°C (77°F)	12 years
Nominal Capacity @ 25°C /77°F	
20 hour rate 5.29A to 1.75Vpc	105 Ah
10 hour rate 10.09A to 1.75Vp	100 Ah

### Internal Resistance

(Fully charged battery @ 25°C /77°F) ..... 5mΩ

Max. Discharge Current @ 25°C /77°F ..... 800 A (5S)

### Charge Methods: Constant voltage charge @ 25°C /77°F

Cycle Use ..... 14.7 ~ 14.9V

Max. Current ..... 25 A

Standby Use ..... 13.6 - 13.8V

Operating Temperature Range ..... -30 ~ 50°C

Notes: battery voltage must be adjusted according to temperature.

Please refer to our recommendation.

### Self-Discharge

3% of capacity declined per month @ 25°C (77°F).

### Battery Picture & Terminal Layout

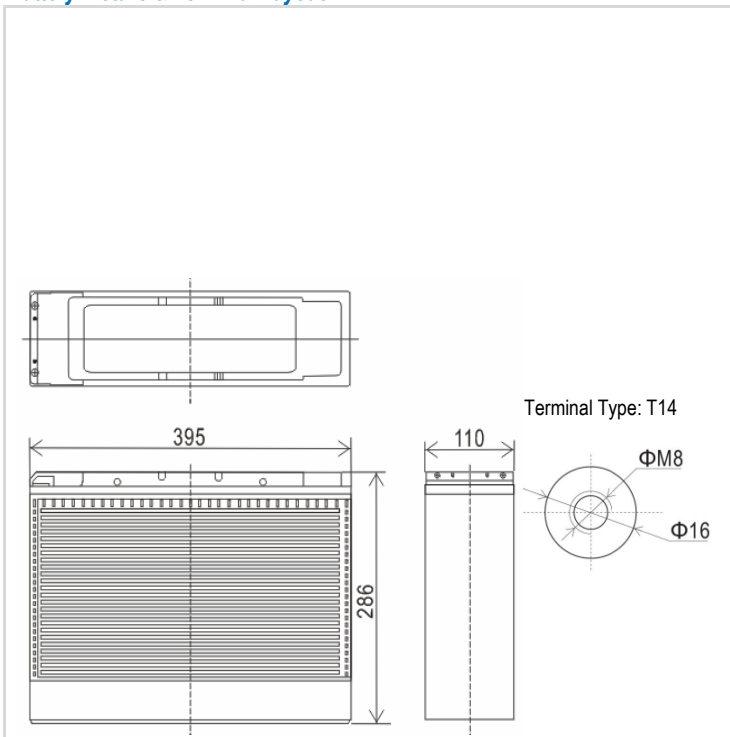

### Dimension & Weight

	Dimension (± 2mm)			Total Height	Weight (± 2%)
	Length	Width	Height		
	395 mm	110 mm	286 mm	286 mm	32.3 kg
	15.6 inch	4.3 inch	11.3 inch	11.3 inch	71.2 lbs

### Typical Applications

- Telecommunications
- Data Center
- Power Utility
- UPS & EPS

### Constant Current Discharge (Amperes @ 25°C /77°F)

V/cell	10min	15min	20min	25min	30min	35min	40min	45min	50min	55min	1hr	2hr	3hr	4hr	5hr	10hr	20hr
1.60	265.4	202.6	176.2	149.9	116.2	98.7	90.2	81.8	75.4	70.5	63.3	42.92	30.09	23.85	19.66	10.28	5.38
1.65	252.4	192.7	168.7	144.6	113.5	96.4	88.1	79.9	73.8	69.1	62.1	42.06	29.60	23.40	19.26	10.28	5.38
1.70	236.9	180.9	159.4	138.0	110.0	93.3	85.4	77.6	71.8	67.5	61.0	41.20	29.00	22.91	18.87	10.18	5.34
1.75	221.4	169.0	150.2	131.4	106.4	90.3	82.7	75.3	69.9	65.9	59.8	40.34	28.41	22.41	18.47	10.08	5.29
1.80	204.5	156.1	140.0	123.9	101.9	86.5	79.5	72.6	67.6	64.1	58.5	39.36	27.82	21.87	17.98	9.88	5.19

### Constant Power Discharge (Watts/cell @ 25°C /77°F)

V/cell	10min	15min	20min	25min	30min	35min	40min	45min	50min	55min	1hr	2hr	3hr	4hr	5hr	10hr	20hr
1.60	444.2	339.1	298.8	258.6	199.6	176.1	162.4	149.0	136.8	125.8	113.3	77.96	55.94	45.11	37.28	19.67	10.41
1.65	432.0	329.8	290.0	250.3	192.4	169.8	156.8	144.0	132.4	122.0	110.2	75.66	55.45	44.71	36.98	19.51	10.32
1.70	416.2	317.7	279.3	241.0	185.3	163.7	151.5	139.5	128.6	118.9	107.9	73.93	54.95	44.32	36.68	19.35	10.24
1.75	399.2	304.7	268.0	231.4	178.2	157.5	145.9	134.5	124.2	115.1	104.8	71.64	54.36	43.87	36.39	19.19	10.15
1.80	379.7	289.8	254.8	219.8	169.3	149.9	139.2	128.7	119.3	111.1	101.7	69.34	53.87	43.48	36.09	19.03	10.07

Subject to revision without notice. Please contact our sales representatives for latest version.

Web: [www.genergybattery.com](http://www.genergybattery.com) | Email: [sales@genergybattery.com](mailto:sales@genergybattery.com)

# NF12-100

12V100Ah / 10hr rate



**Graphs**

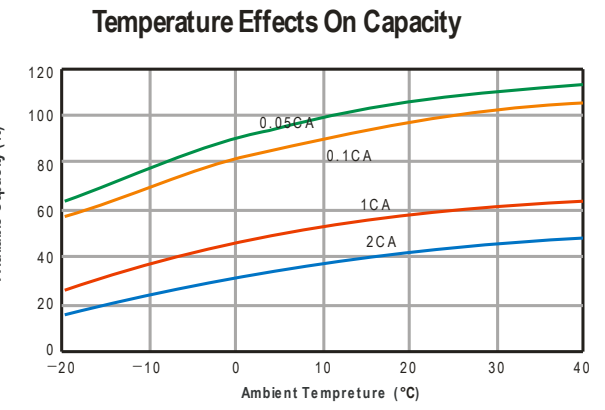
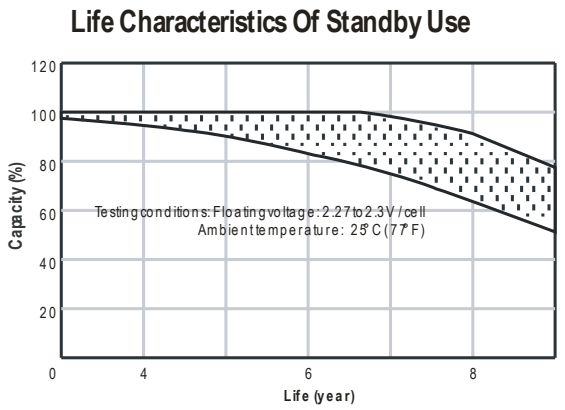
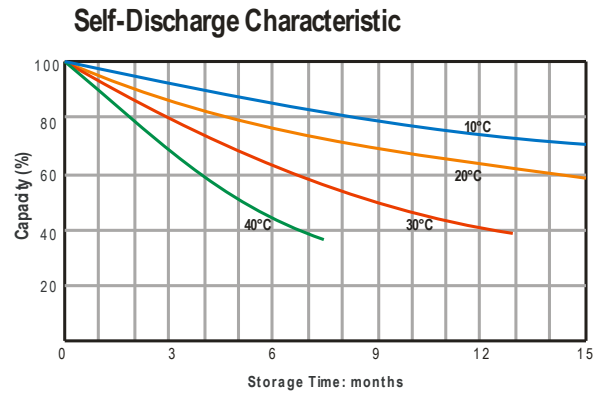
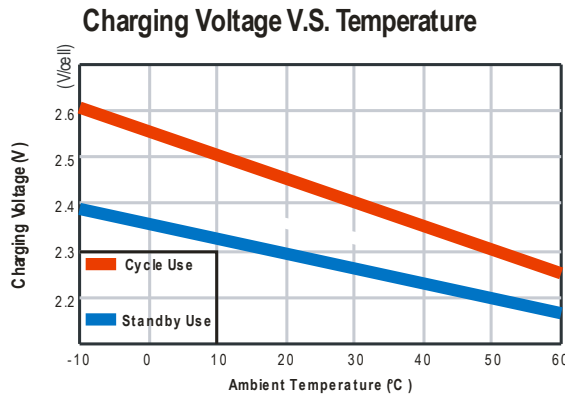
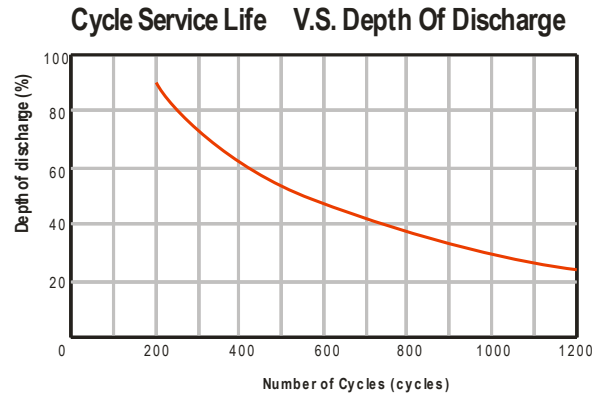
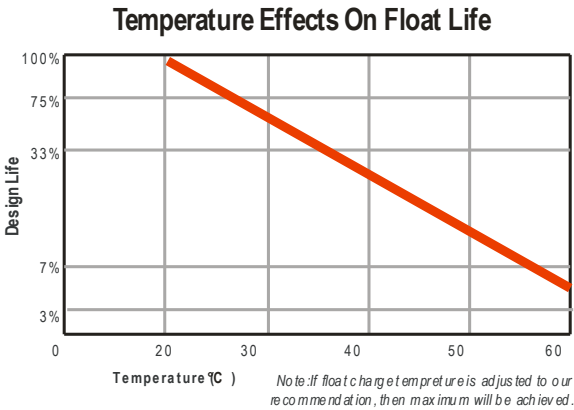
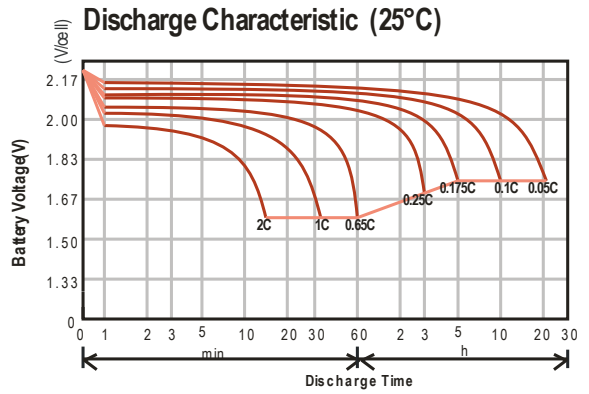
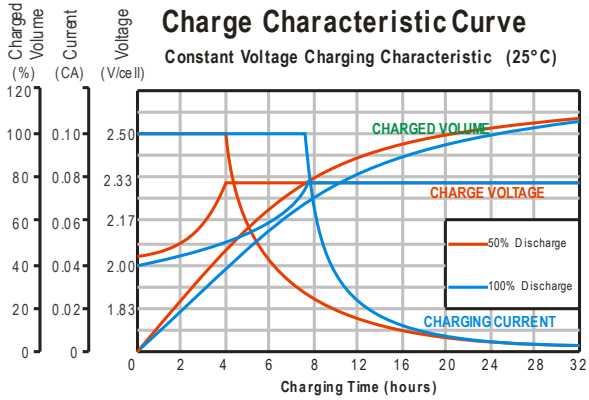

Subject to revision without notice. Please contact our sales representatives for latest version.

Web: [www.genergybattery.com](http://www.genergybattery.com) | Email: [sales@genergybattery.com](mailto:sales@genergybattery.com)