

NF12-150

12V150Ah / 10hr rate



Introduction

Genergy NF (Front Terminal) series is designed for telecommunication UPS/EPS system with 12-year design life in float service. The battery is featured of high consistency, excellent performance and reliable standby service life.

Battery Features

- Compactness
- ETSI 19 inch / 23 inch integration
- Rackable standard component
- High power to volume ratio
- Modularity
- Long life
- Front connection and terminal access
- Central gassing system and hinged front covers on all models
- Fully tank formed plates
- Low impurity electrolyte
- Multi-position usage
- Spill proof / leak proof
- ABS case and cover VO upon request
- Very high purity lead

Electrical Specification

Design floating Life @ 25°C (77°F)	10 years
Nominal Capacity @ 25°C /77°F	
20 hour rate 7.94A to 1.75Vpc	158 Ah
10 hour rate 15.13A to 1.75Vp	151 Ah
Internal Resistance	
(Fully charged battery @ 25°C /77°F)	7mΩ
Max. Discharge Current @ 25°C /77°F	1200 A (5S)
Charge Methods: Constant voltage charge @ 25°C /77°F	
Cycle Use	14.7 ~ 14.9V
Max. Current	45 A
Standby Use	13.6 - 13.8V
Operating Temperature Range	-30 ~ 50°C
<i>Notes: battery voltage must be adjusted according to temperature. Please refer to our recommendation.</i>	
Self-Discharge	
3% of capacity declined per month @ 25°C (77°F).	

Battery Picture & Terminal Layout

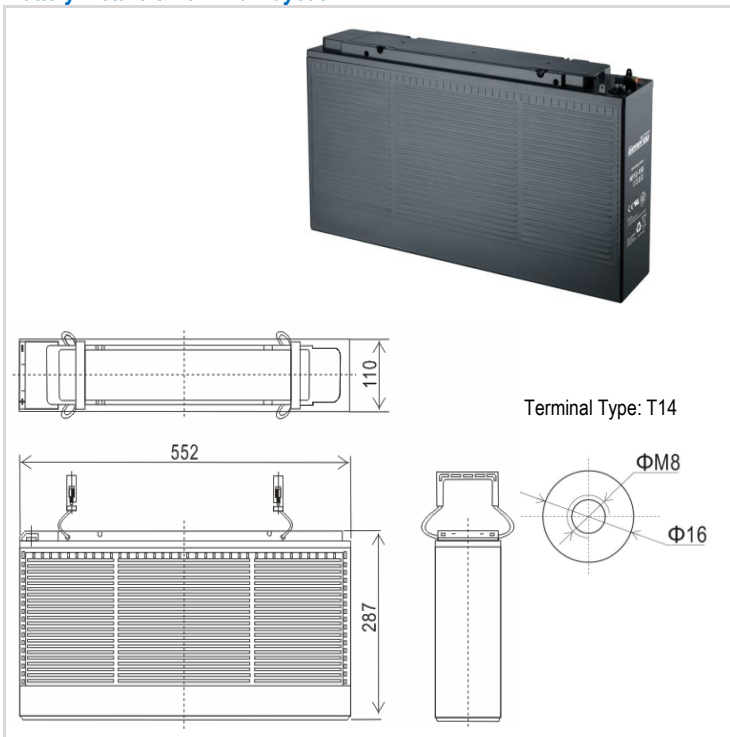

Dimension & Weight

Length	Dimension (± 2mm)			Total Height	Weight (± 2%)
	Width	Height			
552 mm	110 mm	287 mm	287 mm	43.5 kg	
21.7 inch	4.3 inch	11.3 inch	11.3 inch	95.9 lbs	

Typical Applications

- Telecommunications
- Data Center
- Power Utility
- UPS & EPS

Constant Current Discharge (Amperes @ 25°C /77°F)

V/cell	10min	15min	20min	25min	30min	35min	40min	45min	50min	55min	1hr	2hr	3hr	4hr	5hr	10hr	20hr
1.60	398.1	303.9	264.4	224.8	174.3	148.1	135.2	122.7	113.1	105.7	95.0	64.39	45.14	35.77	29.49	15.42	8.08
1.65	378.7	289.1	253.0	216.9	170.3	144.6	132.1	119.9	110.6	103.6	93.2	63.09	44.40	35.10	28.90	15.42	8.08
1.70	355.4	271.3	239.2	207.0	164.9	140.0	128.1	116.4	107.8	101.2	91.5	61.80	43.51	34.36	28.30	15.27	8.00
1.75	332.1	253.5	225.3	197.2	159.6	135.5	124.1	113.0	104.9	98.9	89.7	60.51	42.62	33.62	27.71	15.12	7.94
1.80	306.8	234.2	210.0	185.8	152.9	129.8	119.2	108.8	101.4	96.2	87.8	59.04	41.73	32.81	26.97	14.82	7.78

Constant Power Discharge (Watts/cell @ 25°C /77°F)

V/cell	10min	15min	20min	25min	30min	35min	40min	45min	50min	55min	1hr	2hr	3hr	4hr	5hr	10hr	20hr
1.60	666.3	508.6	448.3	387.9	299.3	264.1	243.6	223.5	205.2	188.7	170.0	116.94	83.91	67.66	55.91	29.50	15.61
1.65	648.0	494.7	435.0	375.4	288.7	254.8	235.2	216.0	198.7	183.1	165.3	113.49	83.17	67.07	55.47	29.27	15.48
1.70	624.3	476.6	419.0	361.4	278.0	245.6	227.2	209.2	192.9	178.4	161.9	110.90	82.43	66.48	55.02	29.03	15.36
1.75	598.7	457.0	402.0	347.0	267.3	236.3	218.8	201.7	186.3	172.7	157.2	107.45	81.54	65.81	54.58	28.79	15.23
1.80	569.5	434.8	382.2	329.7	254.0	224.8	208.7	193.0	179.0	166.6	152.6	104.01	80.80	65.22	54.13	28.55	15.11

Subject to revision without notice. Please contact our sales representatives for latest version.

Web: www.genergybattery.com | Email: sales@genergybattery.com

NF12-150

12V150Ah / 10hr rate



Graphs

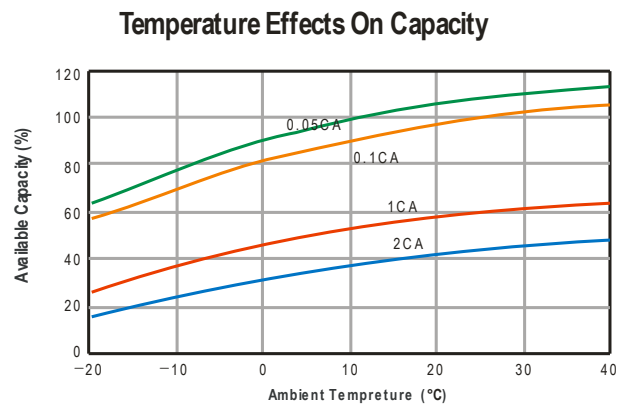
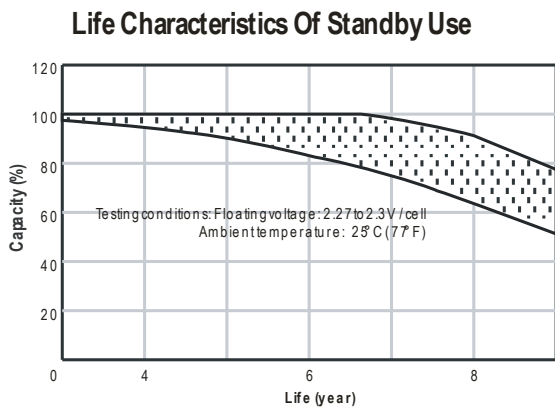
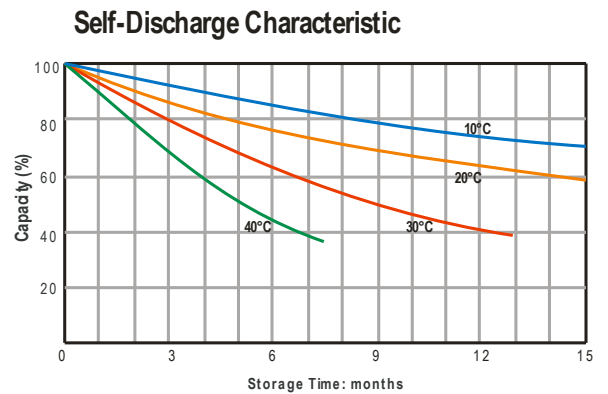
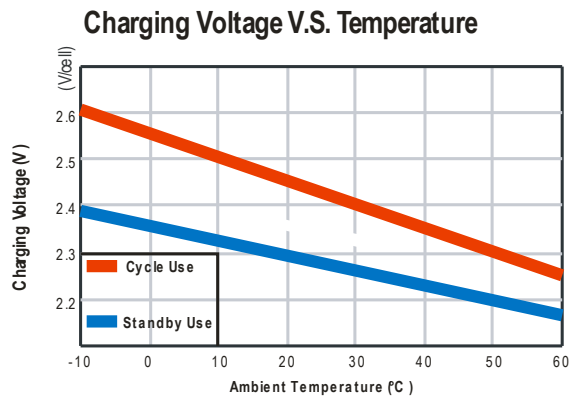
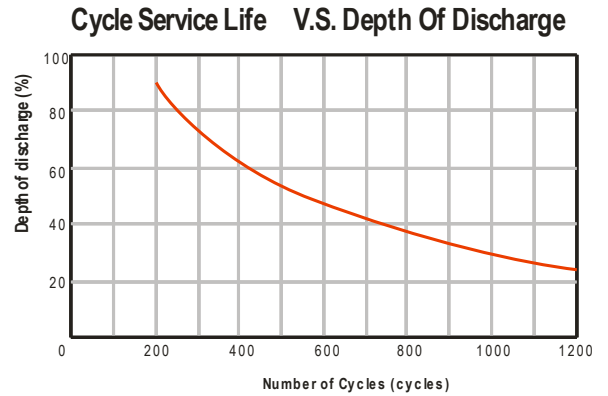
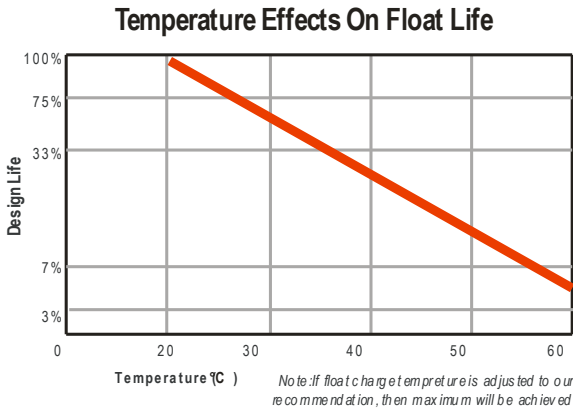
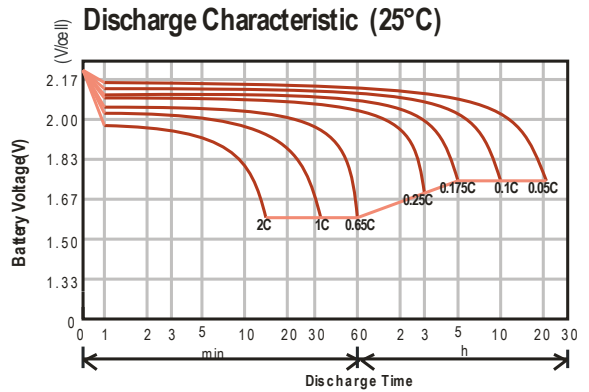
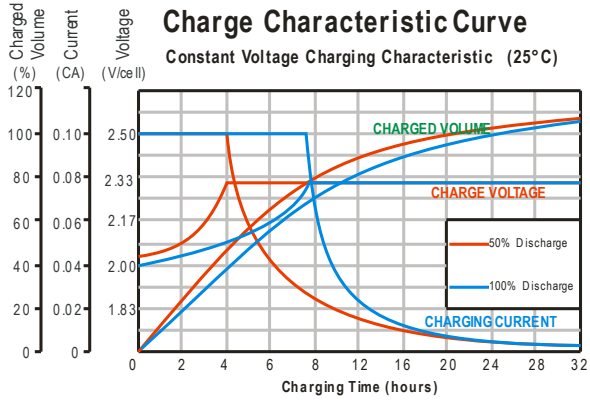

Subject to revision without notice. Please contact our sales representatives for latest version.

Web: www.genergybattery.com | Email: sales@genergybattery.com