

# NS12-8L

12V8Ah / 20hr rate



### Introduction

Generagy NSL (7Ah-28Ah) series is designed for standby use with 10-year design life in float service. The series battery is featured of high consistency, excellent performance and reliable standby service life. It is widely applied in UPS/EPS, medical equipment, emergency light and security system.

### Battery Features

- Low self-discharge
- Fully tank formed plates
- Low impurity electrolyte
- Spill proof / leak proof
- Multi-position usage
- ABS case and cover VO upon request
- very high purity lead

### Electrical Specification

Design floating Life @ 25°C (77°F)	10 years
Nominal Capacity @ 25°C /77°F	
20 hour rate 0.41A to 1.75Vpc	8.2 Ah
10 hour rate 0.77A to 1.75Vpc	7.7 Ah
Internal Resistance	
(Fully charged battery @ 25°C /77°F )	30 mΩ
Max. Discharge Current @ 25°C /77°F	120 A (5S)
Charge Methods: Constant voltage charge @ 25°C /77°F	
Cycle Use	14.7 ~ 14.9V
Max. Current	2 A
Standby Use	13.6 - 13.8V
Operating Temperature Range	-30 ~ 50°C
<i>Notes: battery voltage must be adjusted according to temperature. Please refer to our recommendation.</i>	
Self-Discharge	
3% of capacity declined per month @ 25°C (77°F).	

### Battery Picture & Terminal Layout

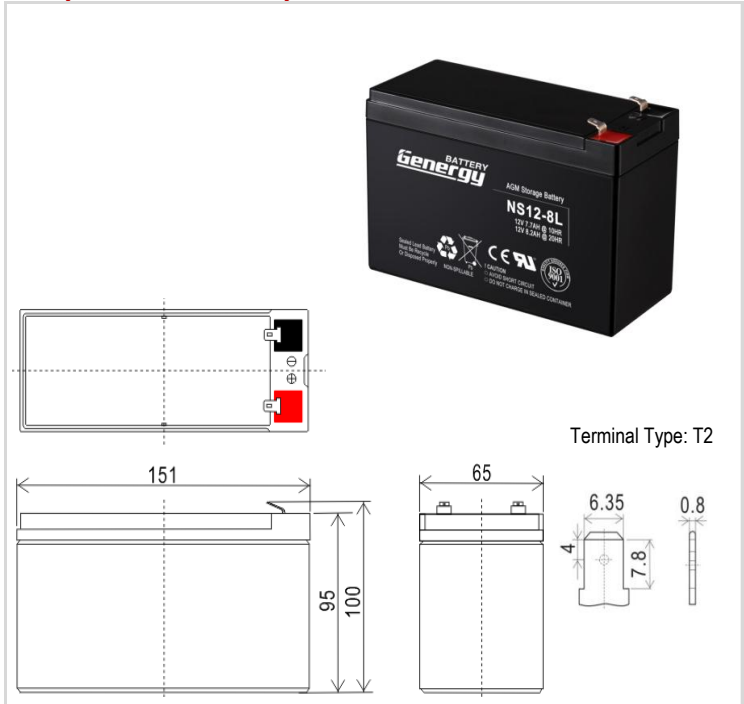

### Dimension & Weight

Length	Dimension (± 2mm)			Weight (± 2%)
	Width	Height	Total Height	
151 mm	65 mm	95 mm	100 mm	2.41 kg
5.9 inch	2.6 inch	3.7 inch	3.9 inch	5.3 lbs

### Typical Applications

- UPS & EPS
- Security Power Supply
- Power Utility
- Electrical Toys

### Constant Current Discharge (Amperes @ 25°C /77°F)

V/cell	10min	15min	20min	25min	30min	35min	40min	45min	50min	55min	1hr	2hr	3hr	4hr	5hr	10hr	20hr
1.60	18.73	14.30	12.22	10.14	8.57	7.45	6.85	6.24	5.75	5.32	5.00	2.57	2.00	1.71	1.48	0.81	0.42
1.65	17.94	13.69	11.71	9.73	8.27	7.18	6.61	6.04	5.58	5.18	4.90	2.51	1.95	1.67	1.46	0.80	0.42
1.70	17.15	13.09	11.21	9.32	7.95	6.90	6.37	5.83	5.41	5.04	4.79	2.45	1.91	1.64	1.43	0.79	0.41
1.75	16.35	12.48	10.71	8.93	7.66	6.64	6.14	5.63	5.24	4.91	4.69	2.39	1.85	1.60	1.41	0.77	0.41
1.80	15.56	11.88	10.21	8.54	7.39	6.40	5.92	5.45	5.08	4.78	4.59	2.33	1.79	1.56	1.38	0.76	0.40

### Constant Power Discharge (Watts/cell @ 25°C /77°F)

V/cell	10min	15min	20min	25min	30min	35min	40min	45min	50min	55min	1hr	2hr	3hr	4hr	5hr	10hr	20hr
1.60	35.87	27.39	23.29	19.20	16.22	14.10	13.09	12.08	11.30	10.41	9.63	5.27	4.02	3.44	2.70	1.64	0.89
1.65	34.42	26.28	22.35	18.42	15.62	13.52	12.55	11.57	10.83	9.97	9.22	5.03	3.91	3.36	2.65	1.63	0.87
1.70	32.97	25.17	21.45	17.72	15.11	13.03	12.08	11.12	10.38	9.54	8.81	4.79	3.81	3.29	2.61	1.61	0.85
1.75	31.79	24.26	20.64	17.02	14.51	12.46	11.54	10.61	9.91	9.09	8.40	4.55	3.69	3.20	2.56	1.59	0.85
1.80	30.34	23.16	19.73	16.31	14.01	11.99	11.10	10.21	9.54	8.76	8.10	4.38	3.56	3.10	2.49	1.57	0.81

Subject to revision without notice. Please contact our sales representatives for latest version.

Web: [www.generagybattery.com](http://www.generagybattery.com) | Email: [sales@generagybattery.com](mailto:sales@generagybattery.com)

# NS12-8L

12V8Ah / 20hr rate



**Graphs**

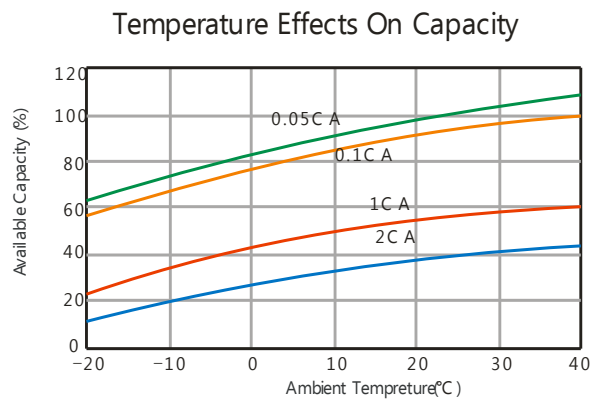
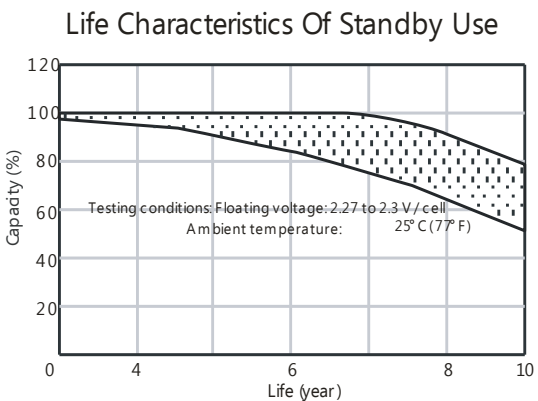
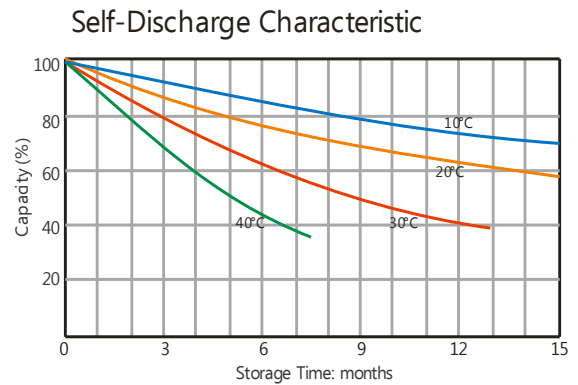
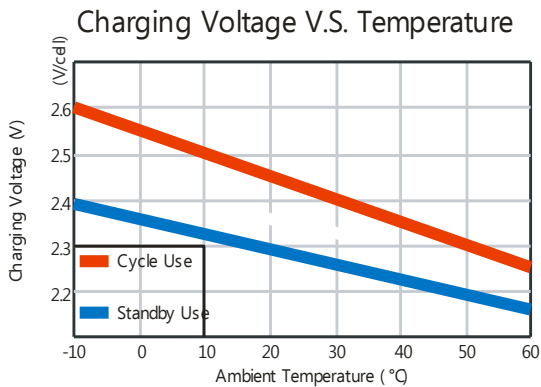
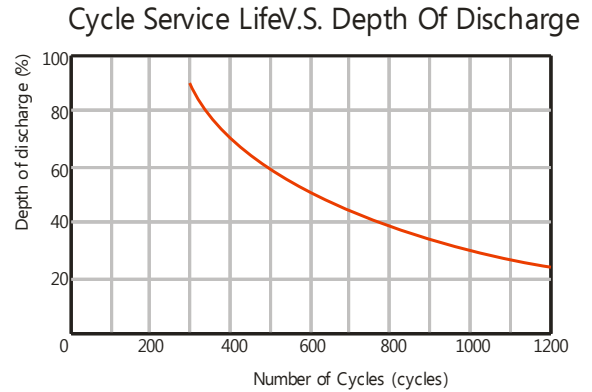
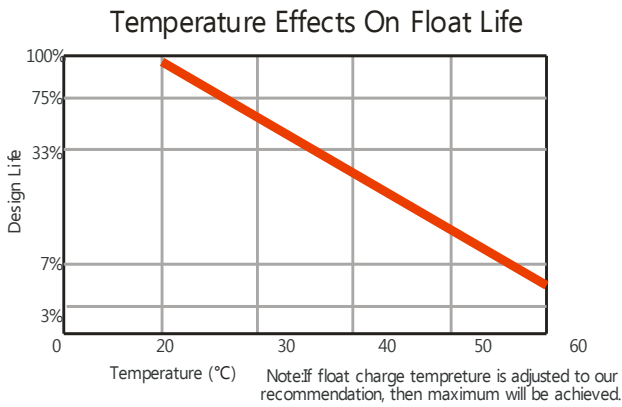
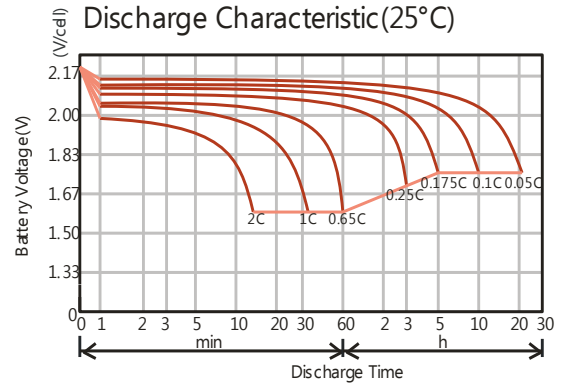
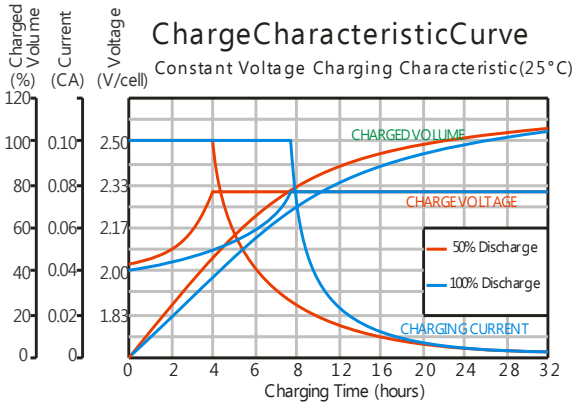

Subject to revision without notice. Please contact our sales representatives for latest version.