

# NF12-50

12V50Ah / 10hr rate



## Introduction

**Generagy NF (Front Terminal) series** is designed for telecommunication UPS/EPS system with 12-year design life in float service. The battery is featured of high consistency, excellent performance and reliable standby service life.

### Battery Features

- Compactness
- ETSI 19 inch / 23 inch integration
- Rackable standard component
- High power to volume ratio
- Modularity
- Long life
- Front connection and terminal access
- Central gassing system and hinged front covers on all models
- Fully tank formed plates
- Low impurity electrolyte
- Multi-position usage
- Spill proof / leak proof
- ABS case and cover VO upon request
- Very high purity lead

### Electrical Specification

Design floating Life @ 25°C (77°F)	12 years
Nominal Capacity @ 25°C /77°F	
20 hour rate 2.65A to 1.75Vpc	53 Ah
10 hour rate 5.04A to 1.75Vpc	50.4 Ah
Internal Resistance	
(Fully charged battery @ 25°C /77°F)	7.5 mΩ
Max. Discharge Current @ 25°C /77°F	400 A (5S)
Charge Methods: Constant voltage charge @ 25°C /77°F	
Cycle Use	14.4 ~ 14.7V
Max. Current	15 A
Standby Use	13.6 - 13.8V
Operating Temperature Range	-30 ~ 50°C
<i>Notes: battery voltage must be adjusted according to temperature. Please refer to our recommendation.</i>	
Self-Discharge	
3% of capacity declined per month @ 25°C (77°F).	

## Battery Picture & Terminal Layout

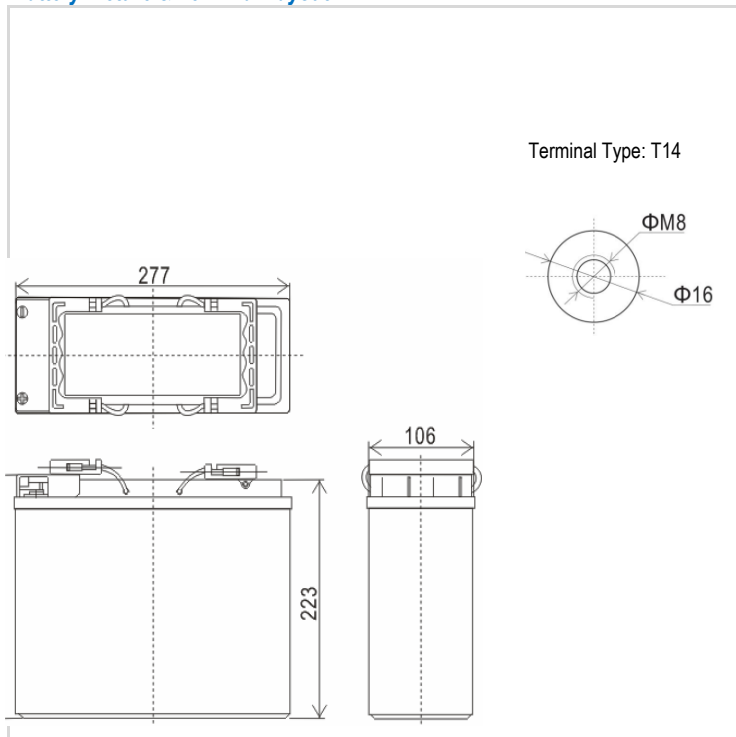

### Dimension & Weight

Length	Dimension (± 2mm)			Total Height	Weight (± 2%)
	Width	Height			
277 mm	106 mm	223 mm	223 mm	18.0 kg	
10.9 inch	4.2 inch	8.8 inch	8.8 inch	39.7 lbs	

### Typical Applications

- Telecommunications
- Power Utility
- Data Center
- UPS & EPS

### Certificates



### Constant Current Discharge (Amperes @ 25°C /77°F)

V/cell	10min	15min	20min	25min	30min	35min	40min	45min	50min	55min	1hr	2hr	3hr	4hr	5hr	10hr	20hr
1.60	132.7	101.3	88.12	74.94	58.09	49.36	45.08	40.88	37.70	35.24	31.65	21.46	15.05	11.92	9.83	5.14	2.69
1.65	126.2	96.4	84.33	72.31	56.76	48.20	44.03	39.95	36.88	34.53	31.07	21.03	14.80	11.70	9.63	5.14	2.69
1.70	118.5	90.4	79.72	69.01	54.98	46.67	42.70	38.81	35.92	33.75	30.49	20.60	14.50	11.45	9.43	5.09	2.67
1.75	110.7	84.5	75.11	65.72	53.20	45.15	41.37	37.67	34.96	32.97	29.92	20.17	14.21	11.21	9.24	5.04	2.65
1.80	102.3	78.1	70.00	61.93	50.97	43.26	39.73	36.28	33.81	32.06	29.26	19.68	13.91	10.94	8.99	4.94	2.59

### Constant Power Discharge (Watts/cell @ 25°C /77°F)

V/cell	10min	15min	20min	25min	30min	35min	40min	45min	50min	55min	1hr	2hr	3hr	4hr	5hr	10hr	20hr
1.60	217.4	166.8	145.14	124.12	96.74	82.66	75.89	69.57	64.49	60.60	54.72	41.64	29.34	23.25	19.27	10.12	5.38
1.65	207.9	158.7	138.90	119.76	94.51	80.70	74.13	67.98	63.09	59.38	54.01	41.01	28.86	22.82	18.88	10.12	5.38
1.70	194.0	148.9	131.31	114.30	91.55	78.15	71.89	66.04	61.45	58.05	53.28	40.17	28.28	22.34	18.49	10.03	5.12
1.75	181.3	139.2	123.71	108.84	88.59	75.60	69.65	64.10	59.81	56.71	52.54	39.53	27.70	21.97	18.10	9.93	5.08
1.80	167.5	131.4	117.85	104.26	85.81	73.22	67.25	62.06	58.16	55.14	51.39	38.57	27.12	21.49	17.71	9.83	5.04

Subject to revision without notice. Please contact our sales representatives for latest version.

Web: [www.generagybattery.com](http://www.generagybattery.com) | Email: [sales@generagybattery.com](mailto:sales@generagybattery.com)

# NF12-50

12V50Ah / 10hr rate



Graphs

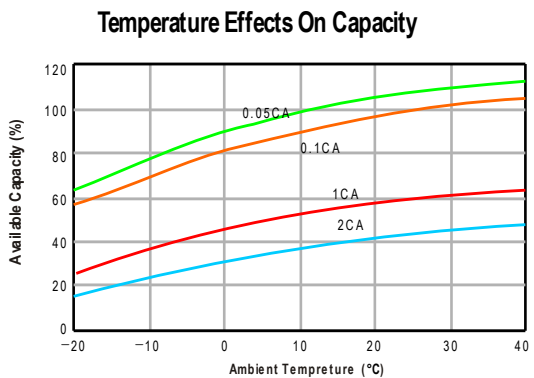
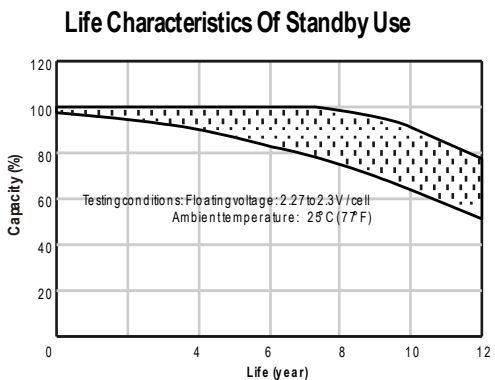
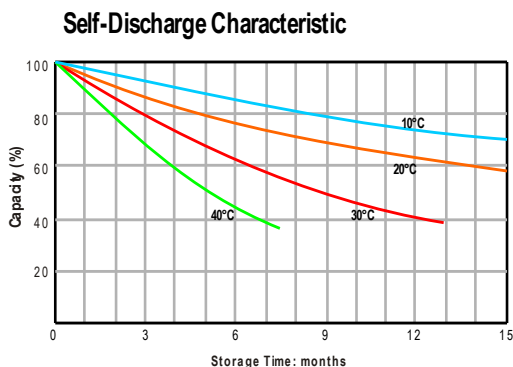
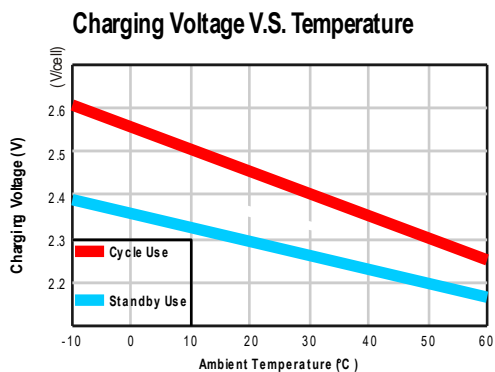
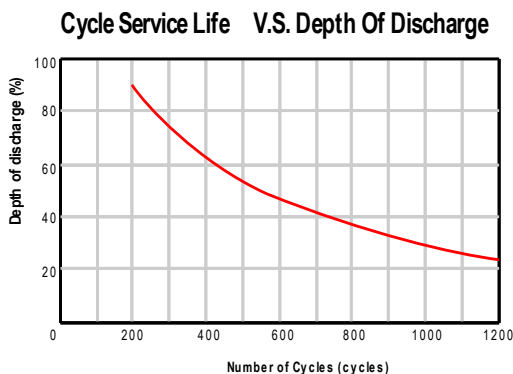
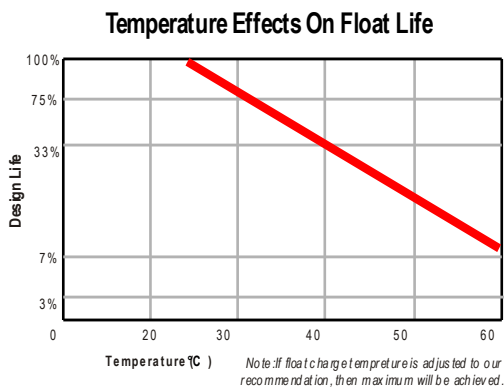
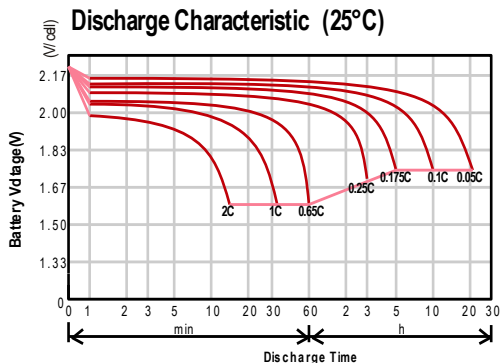
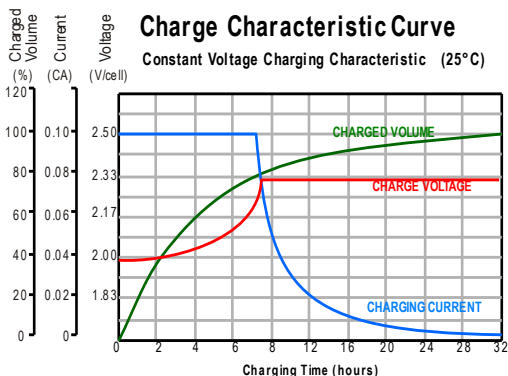

Subject to revision without notice. Please contact our sales representatives for latest version.